User's Manual

For

MA860H

High Performance Microstepping Driver

Version 1.0

©2009 All Rights Reserved

Attention: Please read this manual carefully before using the driver!



The content in this manual has been carefully prepared and is believed to be accurate, but no responsibility is assumed for inaccuracies.

Leadshine reserves the right to make changes without further notice to any products herein to improve reliability, function or design. Leadshine does not assume any liability arising out of the application or use of any product or circuit described herein; neither does it convey any license under its patent rights of others.

Leadshine's general policy does not recommend the use of its products in life support or aircraft applications wherein a failure or malfunction of the product may directly threaten life or injury. According to Leadshine's terms and conditions of sales, the user of Leadshine's products in life support or aircraft applications assumes all risks of such use and indemnifies Leadshine against all damages.



Leadshine Technology Co., Ltd.

3/F, Block 2, Nanyou Tianan Industrial Park, Nanshan Dist, Shenzhen, China

T: (86)755-26434369

F: (86)755-26402718

Web site: www.leadshine.com

E-Mail: sales@leadshine.com

©2009 by Leadshine Technology Company Limited.
All Rights Reserved

Table of Contents

1. Introduction, Features and Applications 1
 Introduction 1
 Features 1
 Applications 1
 2. Specifications 1
 Electrical Specifications 1
 Operating Environment and other Specifications 2
 Mechanical Specifications 2
 Elimination of Heat 3
 3. Pin Assignment and Description 3
 Connector P1 Configurations 3
 Selecting Effective Pulse Edge or Effective Level and Control Signal Mode 3
 Connector P2 Configurations 4
 4. Control Signal Connector (P1) Interface 4
 5. Connecting the Motor 5
 Connections to 4-lead Motors 5
 Connections to 6-lead Motors 5
 Half Coil Configurations 5
 Full Coil Configurations 6
 Connections to 8-lead Motors 6
 Series Connections 6
 Parallel Connections 7
 6. Power Supply Selection 7
 Regulated or Unregulated Power Supply 7
 Multiple Drivers 7
 Selecting Supply Voltage 8
 7. Selecting Microstep Resolution and Driver Output Current 8
 Microstep Resolution Selection 8
 Current Settings 9
 Dynamic current setting 9

Standstill current setting 9
 8. Wiring Notes 10
 9. Typical Connection 10
 10. Sequence Chart of Control Signals 11
 11. Protection Functions 11
 Short-voltage and Over-voltage protection 11
 Over-current Protection 11
 Short Circuit Protection 12
 12. Frequently Asked Questions 12
 Problem Symptoms and Possible Causes 13
 APPENDIX 13
 Twelve month limited warranty 13
 Exclusions 13
 Obtaining warranty service 13
 Warranty limitations 13

1. Introduction, Features and Applications

Introduction

The MA860HH is a high performance microstepping driver based on pure-sinusoidal current control technology. Owing to the above technology and the self-adjustment technology (self-adjust current control parameters) according to different motors, the driven motors can run with smaller noise, lower heating, smoother movement and have better performances at higher speed than most of the drivers in the markets. It is suitable for driving 2-phase and 4-phase hybrid stepping motors.

Features

- ! High performance, cost-effective
- ! Supply voltage up to 80VAC or +110VDC
- ! Output current up to 7.2A
- ! Self-adjustment technology
- ! Pure-sinusoidal current control technology
- ! Pulse input frequency up to 300 KHz
- ! TTL compatible and optically isolated input
- ! Automatic idle-current reduction
- ! 16 selectable resolutions in decimal and binary, up to 51,200 steps/rev
- ! Suitable for 2-phase and 4-phase motors
- ! Support PUL/DIR and CW/CCW modes
- ! Short-voltage, over-voltage, over-current and short-circuit protection

Applications

Suitable for a wide range of stepping motors, from NEMA size 17 to 43. It can be used in various kinds of machines, such as X-Y tables, labeling machines, laser cutters, engraving machines, pick-place devices, and so on. Particularly adapt to the applications desired with low noise, low heating, high speed performance.

2. Specifications

Electrical Specifications (T_j = 25°C/77°F)

Parameters	MA860H			
	Min	Typical	Max	Unit
Output current	1.8	-	7.2 (5.1 RMS)	A
Supply voltage	18	48	80	VAC
	+24	+68	+110	VDC
Logic signal current	7	10	16	mA
Pulse input frequency	0	-	300	KHz
Isolation resistance	500			MΩ

Operating Environment and other Specifications

Cooling	Natural Cooling or Forced cooling	
Operating Environment	Environment	Avoid dust, oil fog and corrosive gases
	Ambient Temperature	0°C — 50°C (32°F — 122°F)
	Humidity	40% RH — 90%RH
	Operating Temperature	70°C (158°F) Max
	Vibration	5.9m/s ² Max
Storage Temperature	-20°C — 65°C (-4°F — 149°F)	
Weight	Approx. 580g (20.46oz)	

Mechanical Specifications (unit: mm[inch])

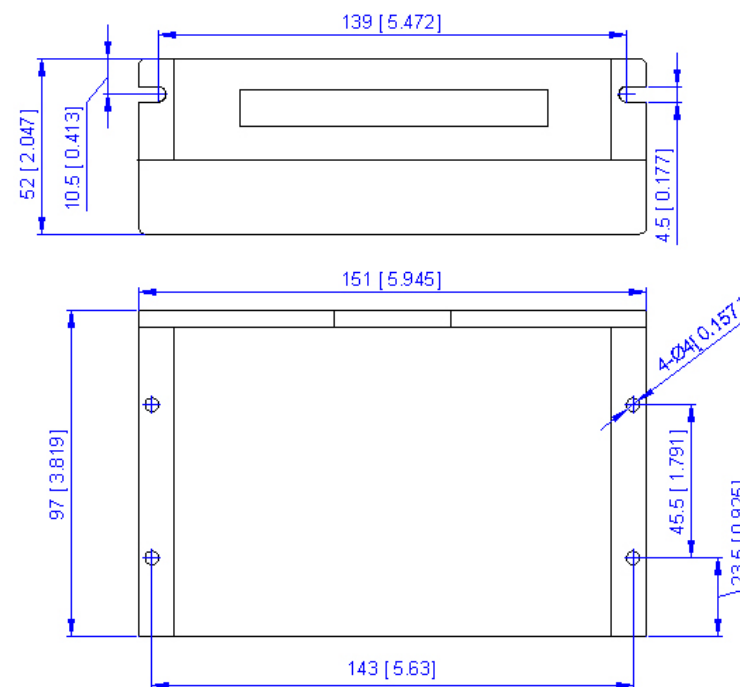

Figure 1: Mechanical specifications

*Recommend use side mounting for better heat dissipation

Elimination of Heat

- Driver's reliable working temperature should be <70°C(158°F), and motor working temperature should be <80°C(176°F);
- It is recommended to use automatic idle-current mode, namely current automatically reduce to 60% when motor stops, so as to reduce driver heating and motor heating;
- It is recommended to mount the driver vertically to maximize heat sink area. Use forced cooling method to cool the system if necessary.

3. Pin Assignment and Description

The MA860H has two connectors, connector P1 for control signals connections, and connector P2 for power and motor connections. The following tables are brief descriptions of the two connectors. More detailed descriptions of the pins and related issues are presented in section 4, 5, 9.

Connector P1 Configurations

Pin Function	Details
PUL+	Pulse signal: In single pulse (pulse/direction) mode, this input represents pulse signal, active at each rising or falling edge (set by inside jumper J3); 4-5V when PUL-HIGH, 0-0.5V when PUL-LOW. In double pulse mode (pulse/pulse), this input represents clockwise (CW) pulse, active at high level or low level (set by inside jumper J3). For reliable response, pulse width should be longer than 1.5μs. Series connect resistors for current-limiting when +12V or +24V used. The same as DIR and ENA signals.
PUL-	
DIR+	DIR signal: In single-pulse mode, this signal has low/high voltage levels, representing two directions of motor rotation; in double-pulse mode (set by inside jumper J1), this signal is counter-clock (CCW) pulse, active at high level or low level (set by inside jumper J3). For reliable motion response, DIR signal should be ahead of PUL signal by 5μs at least. 4-5V when DIR-HIGH, 0-0.5V when DIR-LOW. Please note that motion direction is also related to motor-driver wiring match. Exchanging the connection of two wires for a coil to the driver will reverse motion direction.
DIR-	
ENA+	Enable signal: This signal is used for enabling/disabling the driver. High level (NPN control signal, PNP and Differential control signals are on the contrary, namely Low level for enabling,) for enabling the driver and low level for disabling the driver. Usually left UNCONNECTED (ENABLED) .
ENA-	

Selecting Effective Pulse Edge or Effective Level and Control Signal Mode

There are two jumpers J1 and J3 inside the MA860H specifically for selecting active pulse edge or effective level and control signal mode, as shown in figure 2. Default setting is PUL/DIR mode and upward-rising edge active. (Note: J2 inside the driver is used to reverse the default rotation direction.)

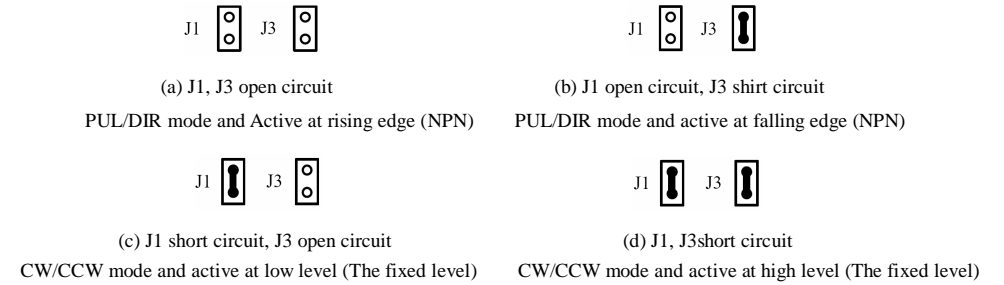

Figure 2: J1 and J3 jumpers

Connector P2 Configurations

Pin Function	Details
AC	Power supply, 18~80 VAC or 24~110 VDC, Including voltage fluctuation
AC	and EMF voltage. Recommended 18-53VAC or 24-75VDC.
A+, A-	Motor Phase A
B+, B-	Motor Phase B

4. Control Signal Connector (P1) Interface

The MA860H can accept differential and single-ended inputs (including open-collector and PNP output). The MA860H has 3 optically isolated logic inputs which are located on connector P1 to accept line driver control signals. These inputs are isolated to minimize or eliminate electrical noises coupled onto the drive control signals. Recommend use line driver control signals to increase noise immunity of the driver in interference environments. In the following figures, connections to open-collector and PNP signals are illustrated.

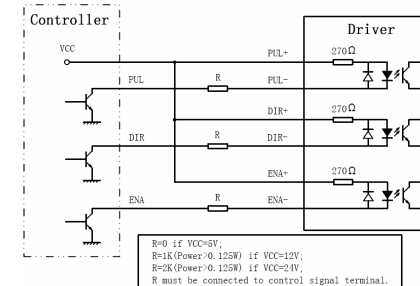

Figure 3: Connections to open-collector signal (common-anode)

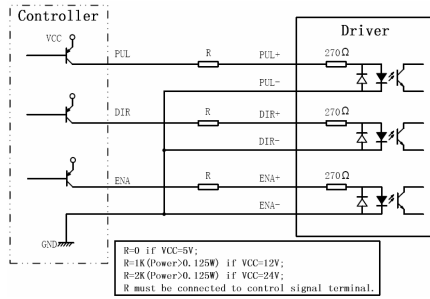

Figure 4: Connection to PNP signal (common-cathode)

5. Connecting the Motor

The MA860H can drive any 2-phase and 4-phase hybrid stepping motors.

Connections to 4-lead Motors

4 lead motors are the least flexible but easiest to wire. Speed and torque will depend on winding inductance. In setting the driver output current, multiply the specified phase current by 1.4 to determine the peak output current.

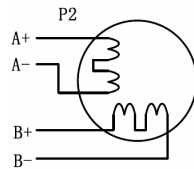

Figure 5: 4-lead Motor Connections

Connections to 6-lead Motors

Like 8 lead stepping motors, 6 lead motors have two configurations available for high speed or high torque operation. The higher speed configuration, or half coil, is so described because it uses one half of the motor's inductor windings. The higher torque configuration, or full coil, uses the full windings of the phases.

Half Coil Configurations

As previously stated, the half coil configuration uses 50% of the motor phase windings. This gives lower inductance, hence, lower torque output. Like the parallel connection of 8 lead motor, the torque output will be more stable at higher speeds. This configuration is also referred to as half chopper. In

setting the driver output current multiply the specified per phase (or unipolar) current rating by 1.4 to determine the peak output current.

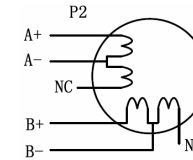

Figure 6: 6-lead motor half coil (higher speed) connections

Full Coil Configurations

The full coil configuration on a six lead motor should be used in applications where higher torque at lower speeds is desired. This configuration is also referred to as full copper. In full coil mode, the motors should be run at only 70% of their rated current to prevent over heating.

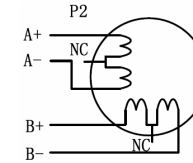

Figure 7: 6-lead motor full coil (higher torque) connections

Connections to 8-lead Motors

8 lead motors offer a high degree of flexibility to the system designer in that they may be connected in series or parallel, thus satisfying a wide range of applications.

Series Connections

A series motor configuration would typically be used in applications where a higher torque at lower speeds is required. Because this configuration has the most inductance, the performance will start to degrade at higher speeds. In series mode, the motors should also be run at only 70% of their rated current to prevent over heating.

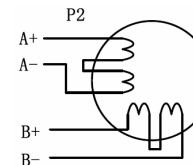

Figure 8: 8-lead motor series connections

Parallel Connections

An 8 lead motor in a parallel configuration offers a more stable, but lower torque at lower speeds. But because of the lower inductance, there will be higher torque at higher speeds. Multiply the per phase (or unipolar) current rating by 1.96, or the bipolar current rating by 1.4, to determine the peak output current.

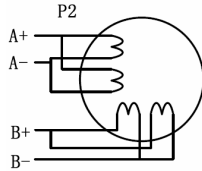

Figure 9: 8-lead motor parallel connections

6. Power Supply Selection

The MA860H can match Large and small size stepping motors (from Nema size 17 to 43) made by Leadshine or other motor manufactures around the world. To achieve good driving performances, it is important to select supply voltage and output current properly. Generally speaking, supply voltage determines the high speed performance of the motor, while output current determines the output torque of the driven motor (particularly at lower speed). Higher supply voltage will allow higher motor speed to be achieved, at the price of more noise and heating. If the motion speed requirement is low, it's better to use lower supply voltage to decrease noise, heating and improve reliability.

Regulated or Unregulated Power Supply

Both regulated and unregulated power supplies can be used to supply the driver. However, unregulated power supplies are preferred due to their ability to withstand current surge. If regulated power supplies (such as most switching supplies.) are indeed used, it is important to have large current output rating to avoid problems like current clamp, for example using 4A supply for 3A motor-driver operation. On the other hand, if unregulated supply is used, one may use a power supply of lower current rating than that of motor (typically 50%~70% of motor current). The reason is that the driver draws current from the power supply capacitor of the unregulated supply only during the ON duration of the PWM cycle, but not during the OFF duration. Therefore, the average current withdrawn from power supply is considerably less than motor current. For example, two 3A motors can be well supplied by one power supply of 4A rating.

Multiple Drivers

It is recommended to have multiple drivers to share one power supply to reduce cost, if the supply

has enough capacity. To avoid cross interference, **DO NOT** daisy-chain the power supply input pins of the drivers. (Instead, please connect them to power supply separately.)

Selecting Supply Voltage

The power MOSFETS inside the MA860H can actually operate within 18 ~ 60VAC or +24 ~ +80VDC, including power input fluctuation and back EMF voltage generated by motor coils during motor shaft deceleration. Higher supply voltage can increase motor torque at higher speeds, thus helpful for avoiding losing steps. However, higher voltage may cause bigger motor vibration at lower speed, and it may also cause over-voltage protection or even driver damage. Therefore, it is suggested to choose only sufficiently high supply voltage for intended applications, and it is suggested to use power supplies with theoretical output voltage of 18 ~ 55VAC or +24 ~ +75VDC, leaving room for power fluctuation and back-EMF.

7. Selecting Microstep Resolution and Driver Output Current

This driver uses an 8-bit DIP switch to set microstep resolution, and motor operating current, as shown below:

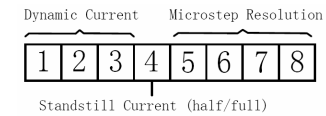

Microstep Resolution Selection

Microstep resolution is set by SW5, 6, 7, 8 of the DIP switch as shown in the following table:

Microstep	Steps/rev.(for 1.8°motor)	SW5	SW6	SW7	SW8
2	400	ON	ON	ON	ON
4	800	OFF	ON	ON	ON
8	1600	ON	OFF	ON	ON
16	3200	OFF	OFF	ON	ON
32	6400	ON	ON	OFF	ON
64	12800	OFF	ON	OFF	ON
128	25600	ON	OFF	OFF	ON
256	51200	OFF	OFF	OFF	ON
5	1000	ON	ON	ON	OFF
10	2000	OFF	ON	ON	OFF

20	4000	ON	OFF	ON	OFF
25	5000	OFF	OFF	ON	OFF
40	8000	ON	ON	OFF	OFF
50	10000	OFF	ON	OFF	OFF
100	20000	ON	OFF	OFF	OFF
200	40000	OFF	OFF	OFF	OFF

Current Settings

For a given motor, higher driver current will make the motor to output more torque, but at the same time causes more heating in the motor and driver. Therefore, output current is generally set to be such that the motor will not overheat for long time operation. Since parallel and serial connections of motor coils will significantly change resulting inductance and resistance, it is therefore important to set driver output current depending on motor phase current, motor leads and connection methods. Phase current rating supplied by motor manufacturer is important in selecting driver current, however the selection also depends on leads and connections.

The first three bits (SW1, 2, 3) of the DIP switch are used to set the dynamic current. Select a setting closest to your motor's required current.

Dynamic current setting

Ref Current (Screen printing)	Peak Current	SW1	SW2	SW3
2.00A	2.40A	ON	ON	ON
2.57A	3.08A	OFF	ON	ON
3.14A	3.77A	ON	OFF	ON
3.71A	4.45A	OFF	OFF	ON
4.28A	5.14A	ON	ON	OFF
4.86A	5.83A	OFF	ON	OFF
5.43A	6.52A	ON	OFF	OFF
6.00A	7.20A	OFF	OFF	OFF

Notes: Ref Current table on the screen printing is used for the users of the M860 to refer. Due to motor inductance, the actual current in the coil may be smaller than the dynamic current setting, particularly under high speed condition.

Standstill current setting

SW4 is used for this purpose. OFF meaning that the standstill current is set to be half of the selected

dynamic current, and ON meaning that standstill current is set to be the same as the selected dynamic current.

The current automatically reduced to 60% of the selected dynamic current one second after the last pulse. Theoretically, this will reduce motor heating to 36% (due to $P=I^2 \cdot R$) of the original value. If the application needs a different standstill current, please contact Leadshine.

8. Wiring Notes

- I In order to improve anti-interference performance of the driver, it is recommended to use twisted pair shield cable.
- I To prevent noise incurred in PUL/DIR signal, pulse/direction signal wires and motor wires should not be tied up together. It is better to separate them by at least 10 cm, otherwise the disturbing signals generated by motor will easily disturb pulse direction signals, causing motor position error, system instability and other failures.
- I If a power supply serves several drivers, separately connecting the drivers is recommended instead of daisy-chaining.
- I It is prohibited to pull and plug connector P2 while the driver is powered ON, because there is high current flowing through motor coils (even when motor is at standstill). Pulling or plugging connector P2 with power on will cause extremely high back-EMF voltage surge, which may damage the driver.

9. Typical Connection

A complete stepping system should include stepping motor, stepping driver, power supply and controller (pulse generator). A typical connection is shown as figure 10.

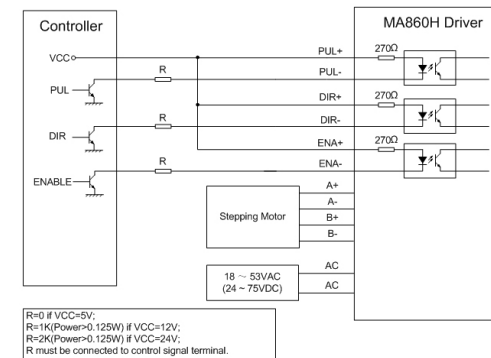

Figure 10: Typical connection

10. Sequence Chart of Control Signals

In order to avoid some fault operations and deviations, PUL, DIR and ENA should abide by some rules, shown as following diagram:

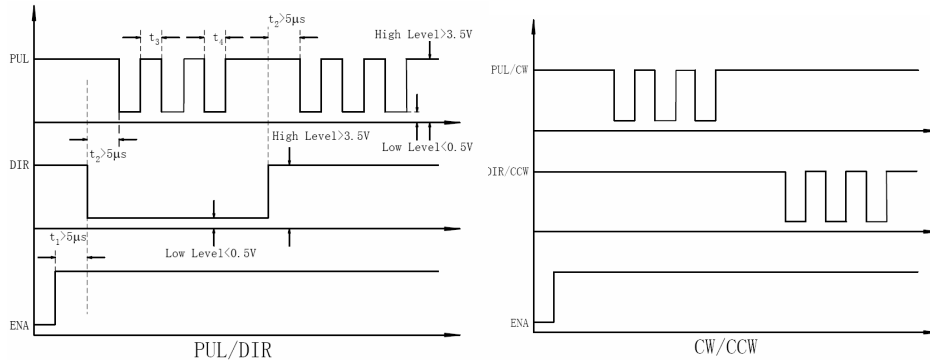

Figure 11: Sequence chart of control signals

Remark:

- t1: ENA must be ahead of DIR by at least $5\mu\text{s}$. Usually, ENA+ and ENA- are NC (not connected). See “Connector P1 Configurations” for more information.
- t2: DIR must be ahead of PUL effective edge by $5\mu\text{s}$ to ensure correct direction;
- t3: Pulse width not less than $1.5\mu\text{s}$;
- t4: Low level width not less than $1.5\mu\text{s}$.

11. Protection Functions

To improve reliability, the driver incorporates some built-in protections features.

Short-voltage and Over-voltage protection

When power supply voltage is lower than 13VAC or +18VDC, short-voltage protection will be activated and power indicator LED will blink. When power supply voltage exceeds 123VAC or +173VDC, over-voltage protection will be activated and Alarm indicator LED will turn on.

Over-current Protection

Protection will be activated when continuous current exceeds the limit.

Short Circuit Protection

Protection will be activated in case of short circuit between motor coils or between motor coil and ground.

12. Frequently Asked Questions

In the event that your driver doesn't operate properly, the first step is to identify whether the problem is electrical or mechanical in nature. The next step is to isolate the system component that is causing the problem. As part of this process you may have to disconnect the individual components that make up your system and verify that they operate independently. It is important to document each step in the troubleshooting process. You may need this documentation to refer back to at a later date, and these details will greatly assist our Technical Support staff in determining the problem should you need assistance.

Many of the problems that affect motion control systems can be traced to electrical noise, controller software errors, or mistake in wiring.

Problem Symptoms and Possible Causes

Symptoms	Possible Problems
Motor is not rotating	No power
	Microstep resolution setting is wrong
	DIP switch current setting is wrong
	Fault condition exists
	The driver is disabled
Motor rotates in the wrong direction	Motor phases may be connected in reverse
The driver in fault	DIP switch current setting is wrong
	Something wrong with motor coil
Erratic motor motion	Control signal is too weak
	Control signal is interfered
	Wrong motor connection
	Something wrong with motor coil
Motor stalls during acceleration	Current setting is too small, losing steps
	Current setting is too small
	Motor is undersized for the application
	Acceleration is set too high
Excessive motor and driver heating	Power supply voltage too low
	Inadequate heat sinking / cooling
	Automatic current reduction function not being utilized
	Current is set too high

APPENDIX

Twelve month limited warranty

Leadshine Technology Co., Ltd. warrants its products against defects in materials and workmanship for a period of 12 months from shipment out of factory. During the warranty period, Leadshine will either, at its option, repair or replace products which proved to be defective.

Exclusions

The above warranty does not extend to any product damaged by reasons of improper or inadequate handlings by customer, improper or inadequate customer wirings, unauthorized modification or misuse, or operation beyond the electrical specifications of the product and/or operation beyond environmental specifications for the product.

Obtaining warranty service

To obtain warranty service, a returned material authorization number (RMA) must be obtained from customer service at e-mail: tech@leadshine.com before returning product for service. Customer shall prepay shipping charges for products returned to Leadshine for warranty service, and Leadshine shall pay for return of products to customer.

Warranty limitations

Leadshine makes no other warranty, either expressed or implied, with respect to the product. Leadshine specifically disclaims the implied warranties of merchantability and fitness for a particular purpose. Some jurisdictions do not allow limitations on how long and implied warranty lasts, so the above limitation or exclusion may not apply to you. However, any implied warranty of merchantability or fitness is limited to the 12-month duration of this written warranty.

Shipping failed product

If your product fail during the warranty period, e-mail customer service at tech@leadshine.com to obtain a returned material authorization number (RMA) before returning product for service. Please include a written description of the problem along with contact name and address. Send failed product to distributor in your area or: Leadshine Technology Co., Ltd. 3/F, Block 2, Nanyou Tianan Industrial Park, Nanshan Dist, Shenzhen, China. Also enclose information regarding the circumstances prior to product failure.